

Complete Web to Panel Laminating System

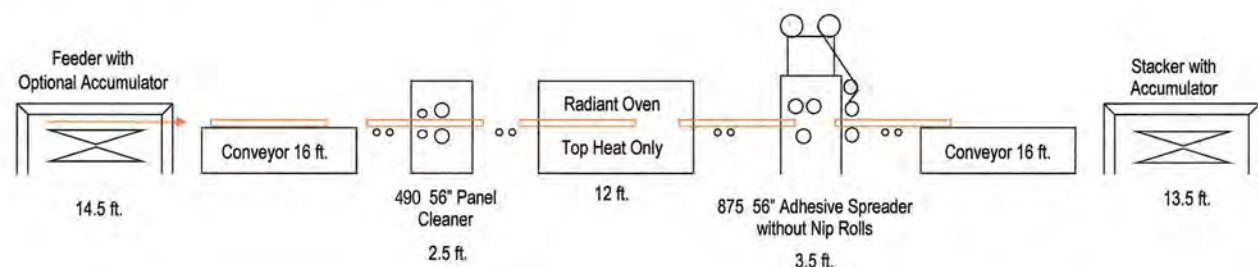

Basic Web to Web Laminating System

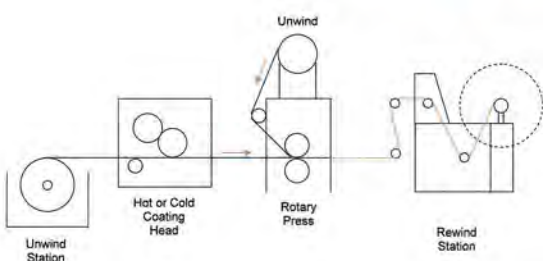

Bulletin RP
7-7721-05121
© 2016



Corporate Headquarters
BLACK BROS. CO.
501 Ninth Avenue
P.O. Box 410
Mendota, IL 61342-0410
Phone: 815.539.7451
Fax: 815.538.2451
www.blackbros.com
info@blackbros.com

Southeast
BLACK BROS. CO.
SOUTHEAST DIVISION
1315 Baker Road
P.O. Box 4226
High Point, NC 27263-4226
Phone: 336.431.9145
Fax: 336.431.9275

800-252-2568 | www.blackbros.com | 815-539-7451



Web Laminating Rotary Press Systems

Our Pledge To You

We at Black Bros. Co. are ever mindful that the reason we have been successful since 1882 is because of you – our customers.

Our relationships are based on trust, fairness, and honesty. We pledge to deliver products and service in an effective and timely manner that meets your needs. Our team members will offer superior customer service, along with the highest quality machinery and systems for your roll coating and laminating needs. We pledge to find solutions for your company and bring increased value to your processes. Thank you.

Various Applications for Rotary Pneumatic Presses

Black Bros. Web Laminating Rotary Press Systems are in use around the world laminating flexible films, foams, fabrics, paper, plastics, etc. Whether a protective film to rigid panels or combining various different types of webs using heat and pressure to laminate a wide range of products.

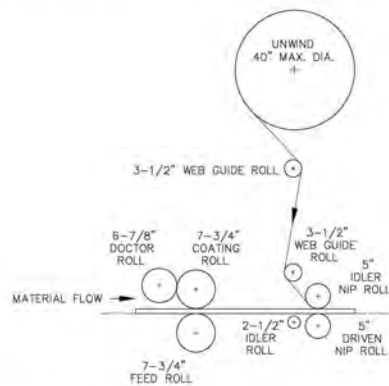

Web Lamination to Rigid Panels

- Radiant Barrier Shields
- Store Fixtures
- EPS Insulation Panels
- Protective Films
- Vinyl Clad to Metal Panel
- Sound Deadening Insulation Panels
- Automotive Headliners

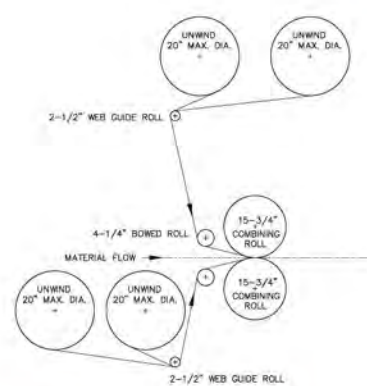

Flexible Webs Laminated Together

- Flexible Insulations
- Foil to Film
- Film to Foam
- Pressure Sensitive Tapes
- Fabric to Foam
- Abrasive Pads
- Carpet Padding

Rotary Laminator 750

Roll Nip Press for laminating sheet to sheet material or pressure sensitive films to sheet.

Simple but efficient RL-750 can do pinch laminating for lightweight panels, honeycomb, doors, countertop, etc. Also, with top unwind station, can laminate pressure sensitive protective films to sheets of metal, glass, and composites.
Nip pressure 2,000 lbs.
230/460V-3Ph-60Hz



Shown with Top Unwind Station

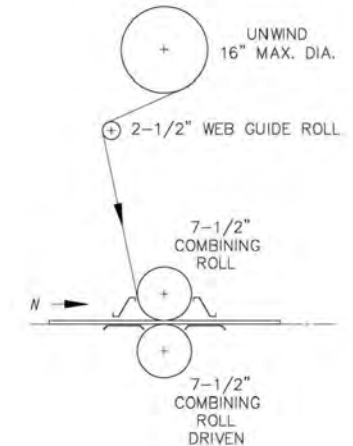

Rotary Pneumatic Press 875

Black Bros. mid-range offering for web lamination.



The RPP-875 can laminate sheet to sheet or laminate 1 or 2 webs to sheet top and bottom 26\"/>

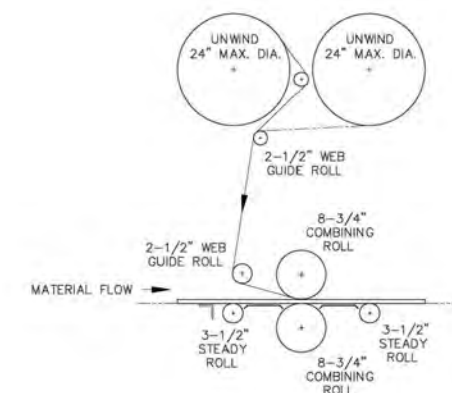

775 Adhesive Roll Coater With Out Feed Nip Station

For laminating web-to-rigid products



This compact Roll Coater and Rotary Press applies water base or hot melt adhesive to various rigid substrates such as OSB, particleboard, and other non-wood panels, then nips web to substrate. Ideal for radiant barrier shield and other building insulation panels. Up to 5'1525 mm in width and up to 12"/300 mm in thickness. 230/460V-3Ph-60Hz

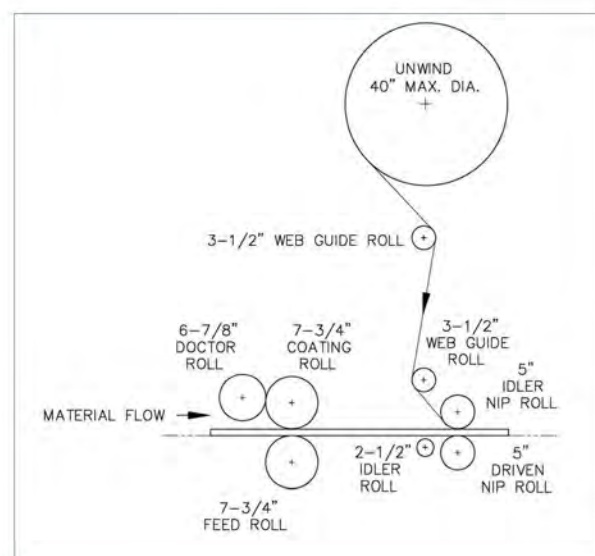

Custom Web Converting & Laminating Systems



Black Bros. will partner with your company and people to design custom web coating and laminating systems that meet your custom requirements to convert various materials for value added benefits. Black Bros. can integrate custom coating and laminating machinery into your current system.

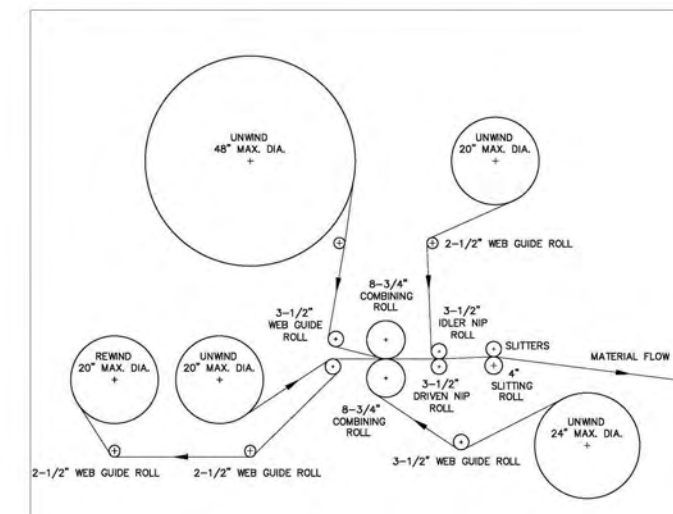

Rotary Pneumatic Press C1575

For both web-to-rigid panels and web-to-web lamination

Black Bros. largest RPP with 15-3/4"/400 mm dia. Rollers up to 144"/3700 mm in length. RPP-C1575 can be supplied with heated rollers for heat sensitive adhesive films or thermally softened substrates.

Nip pressure up to 10,000 lbs.
230/460V-3Ph-60Hz

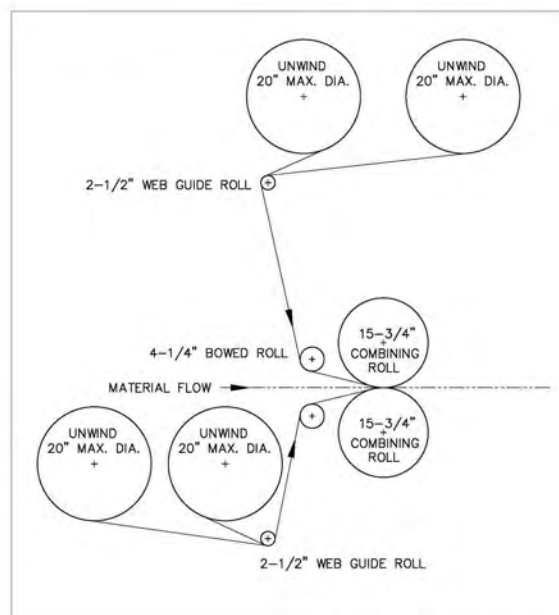

With Human Interface Touch Screen



Optional Features



Heated rollers for heat reactive products up to 232° C./450°F. and speeds up to 300 fpm/91 mpm. Silicone, chrome, or teflon covered rollers available.



Unwinds and rewinds for any kind of flexible web product. Complete system approach with web alignment adjustment.

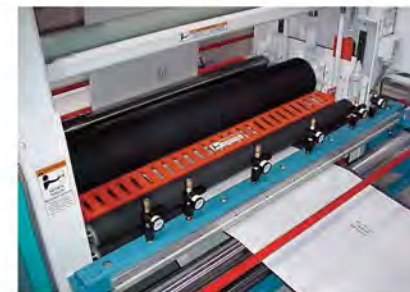

Slitting/ trimming options for sizing of various webs.



Web unwinds with Air Shafts, Air Brake and Tension Control.

Lab/Service



Lab Capabilities

Our laboratory located in Mendota, Illinois has a full range of equipment to demonstrate how a web-to-sheet, web-to-web laminate can be incorporated into your processes.



Service

Three Field Service Technicians with 40 years combined experience. Two Inside Service Representatives to assist with questions, repair orders, training, service appointments, and machine manuals. Black Bros. services over 3000 installations worldwide.